

# Measurement of the redox potential of wine

J. W. TOMLINSON, P. A. KILMARTIN\*

*Department of Chemistry, Victoria University of Wellington, New Zealand*

Received 15 August 1996; revised 4 February 1997

A reproducible method for measuring the redox potential of wines using platinum electrodes was developed involving a consistent electrode pretreatment and carefully controlled experimental conditions. Reproducibility favoured platinized electrodes ( $\pm 3$  mV), over unplatinized electrodes ( $\pm 6$  mV), while poisoning was found to have a greater effect on platinized electrodes. However, the dependence of the potential upon the degree of platinization indicated that both platinized and unplatinized electrodes should be used to maximize the information obtained about the redox state of a wine. A linear relationship was observed between the potential and pH of 26 wines tested, particularly on platinized electrodes. The measured potentials are discussed in terms of mixed potential theory and the influence of adsorbates.

Keywords: *platinized electrodes, redox potential, wine*

## 1. Introduction

It has long been known that oxidation and reduction reactions play a key role in the maturation of wines. Likewise, the correct balance of oxidized and reduced substances has been considered vital to the optimum taste of a wine. Measurement of this parameter should allow an important aspect of wine development to be characterized, even directing the wine maker in optimizing the conditions of wine making.

There are several stages in the wine-making process in which the redox potential may be significant. The fermentation of sugars is an oxidation process controlled by enzymes which can be affected by redox substances like SO<sub>2</sub> or O<sub>2</sub>. With cask or tank ageing, oxidation can be beneficial or detrimental to the quality of the wine, depending upon the extent of oxidation, and the use of antioxidants such as ascorbic acid. Oxygen absorbed when casks are topped up is responsible for many of the oxidative changes which occur. When a wine is bottled, it may be useful to know whether the wine can be described as 'oxidative' or 'reductive'. Highly reductive wines are likely to end up with unpleasant odours due to reduced sulfur compounds, while aldehydes formed by the oxidation of various alcohols also affect the flavour and bouquet.

One measure of the redox potential of a solution is given by an inert 'redox electrode'. An ideal redox electrode should behave reversibly and play no role in the medium other than to act as a source or sink of electrons for the electrochemical reactions that occur. Although acting as an electrocatalyst, the redox electrode should not be so active as to change the redox state of the wine rapidly during the measure-

ment period. However, in the complex mixture of organic substances which constitutes a wine, the reactions of general wine maturation may differ from those which are preferentially activated by the redox electrode; the usual catalysts in wine are thought to be enzymes, microorganisms and metal ions in small concentrations. Nevertheless, the measured redox potential should indicate the relative oxidizing or reducing strength of the solution, particularly in contrast to other wines and to other stages in the wine's development.

Rigorously the redox potential applies to systems that are reversible and have reached equilibrium, and is usually defined with respect to a single charge carrier such as the ferrous/ferric ion couple. When the solution contains a variety of charge carriers, chemical reactions can take place as the more reducing systems reduce the more oxidizing systems, which can occur some distance apart on the redox electrode. In this case the potential recorded by the electrode is not an equilibrium redox potential but a steady state 'mixed potential', where the sum of the anodic and cathodic currents is zero. In wine the electrode may indicate a mixed potential due to many systems, or due to a few systems which are dominant. In measuring the redox potential of water systems, for example, some researchers argue that the redox electrode reacts to a single redox system, as for natural lake waters [1], while other researchers allow for the appearance of mixed potentials under other conditions [2–4].

Previous research on the redox potential of wine has been undertaken mainly using platinum electrodes [5–11], the most extensive studies being those undertaken by Deibner and Mourgues [12–27]. It has been commonly shown that the redox potential

\* Present address: Department of Chemistry, The University of Auckland, Private Bag 92019, Auckland, New Zealand.

falls during fermentation, rises during processing, probably as a result of aeration, and falls again with wine ageing in casks or bottles. The formation of the bouquet involving reduction processes has been linked to the progressive drop in the redox potential as a critical factor [28]. Research into the measurement of the redox potential of wine is continuing [29–31], with Vivas *et al.* developing a technique which allows for more rapid stabilization of the potential [32], while other researchers claim that the redox potential correlates with a sensory evaluation of Yugoslavian wines [33, 34].

However, to improve the reproducibility of the measurement, our interest was directed to a special type of platinum surface well suited for redox potential measurements formed by electrolytic platinization. With a considerably enhanced real surface area platinized platinum is expected to offer more rapid potential stabilization. Differences in the electrocatalytic behaviour of platinized and unplatinized platinum electrodes have been reported [35], as in the electrooxidation of methanol, where changes in the kinetic characteristics of the electrode processes have been noted [36, 37].

The present work describes the development of a method for measuring the redox potential of wine using both platinized and unplatinized electrodes. Results are also presented for an initial study of a range of New Zealand and other wines. The application of mixed potential theory to the measured potentials, and the influence of adsorbed species as indicated by past experiments on the redox potential of organic solutions, are also explored.

## 2. Experimental procedure

Unless otherwise stated the following steps were followed. Both unplatinized and  $9.50 \text{ mg cm}^{-2}$  platinized wire electrodes, (0.5 mm diam. by 5 mm long), were used in the standard measurement technique. To obtain reproducible results the electrodes were consistently prepared using the following chemical cleaning:

- (i) Dipping in boiling 1,1,1-trichloroethane for 5 min (to remove organic impurities);
- (ii) Dipping in hot aqua regia for 5 min, (1:1 HCl to  $\text{HNO}_3$ ) (to etch the platinum down to a consistent surface);
- (iii) Dipping in hot concentrated nitric acid for 5 min (to form a thin oxide layer on the platinum surface [38]);
- (iv) Soaking in 'alconox' detergent for several hours (to promote the adherence of platinized platinum);
- (v) Cathodizing in  $0.1 \text{ mol L}^{-1} \text{ H}_2\text{SO}_4$  at  $30 \text{ mA cm}^{-2}$  for 10 min (which some researchers believe produces an invisible film of platinum 'black' essential for the rapid reduction of  $\text{PtCl}_6^{2-}$  when platinizing [38]);
- (vi) Rinsing and storing in double distilled water.

After each of the above steps, the electrodes were rinsed with double distilled water.

If the electrodes were to be used in an unplatinized state, storage in double distilled water was the final pretreatment. If the electrodes were to be platinized this occurred soon after cathodizing. The platinizing procedure was based upon the work of Feltham and Spiro [38, 39]. In this procedure a solution of 3.5 ( $\pm 0.1$ )% (w/v) ( $0.072 \text{ mol L}^{-1}$ ) chloroplatinic acid ( $\text{H}_2\text{PtCl}_6 \cdot 6\text{H}_2\text{O}$ ) in  $2 \text{ mol L}^{-1} \text{ HCl}$  was required as the platinizing solution, which was kept at a constant concentration. To determine the concentration of the  $\text{PtCl}_6^{2-}$  ion, the spectrophotometric technique outlined by Kirkland and Yoe [40] was used, based upon the absorption maximum at 262 nm.

The electrodes were platinized using a three compartment cell in a water bath set at  $25.0^\circ\text{C}$ , with a quinhydrone reference electrode in  $0.144 \text{ M HCl}$  and the potential controlled by a PAR 173 potentiostat-galvanostat with PAR 179 digital coulometer. A potential of  $-0.505 \text{ V}$  was applied until a deposition of  $9.50 \text{ mg cm}^{-2}$  ( $1.8 \text{ C cm}^{-2}$ ), was achieved, which usually required 21 to 25 mins. The electrodes were finally rinsed and stored in double distilled water until being used.

The cells were designed to be filled completely with wine and to have the electrodes inserted horizontally from the sides, thus avoiding a headspace. Figure 1 shows the design of such a cell, two of which were used for each measurement to test reproducibility. A different type of cell with a headspace and with electrodes inserted vertically was used in some of the preliminary investigations.

To make the measurement itself, the wine bottle was uncorked under oxygen-free nitrogen and a stopper with septum was inserted into the bottle. The cells were thermostatted at  $25.0^\circ\text{C}$  and contained a magnetic stirrer, a saturated calomel reference elec-

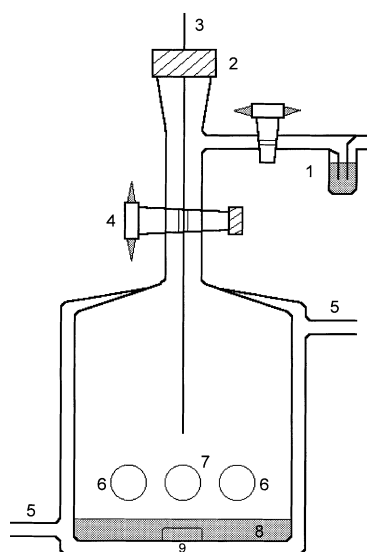

Fig. 1. Measurement cell: (1) bubbler, (2) top with rubber disc, (3) hypodermic tubing, (4) teflon tap, (5) water jacket connected to water bath, (6) redox electrodes, (7) reference electrode (SCE) inserted from the opposite side, (8) wine and (9) magnetic stirrer.

trode (242 mV), a  $9.50 \text{ mg cm}^{-2}$  platinized and an unplatinized redox electrode. A hypodermic needle was inserted via the rubber disc at the top of each cell, through which oxygen-free nitrogen was passed for at least 15 min to flush out the oxygen. Wine was then transferred in a darkened environment to the cells from the bottle clamped upside down above the cell, and the cell atmosphere was released through the bubblers. Oxygen-free nitrogen was forced into the bottle to increase the rate of cell filling and so minimize the time which the electrodes were exposed to wine vapour.

The electrodes were connected to a Hewlett Packard HP3421A data acquisition unit operated by a Hewlett Packard HP86B computer, and readings were taken every 60 s. Once the cells were a quarter filled, the magnetic stirrers were turned on at a rate of 500 rpm (calibrated by stroboscope), to provide constant stirring conditions from the onset. Once the wine rose above the teflon tap the hypodermic tubing was removed and the teflon and bubbler taps were closed. The whole system was covered with a thick black cloth to minimize exposure to light. Potential measurements were usually taken for about 20 h, the readings being taken less frequently later in the run. The pH of the wine was also measured using a radiometer PHM 64 research pH meter.

The initial potential minimum, which usually occurred within the first hour of each experiment, was taken as the value of the redox potential of the platinized electrodes, ( $E'$  in Fig. 2). The possibility of extrapolating to a theoretical potential value in the absence of poisoning effects, ( $E''$  in Fig. 2), was resisted. (The factors affecting this rise in potential are

discussed later in the paper.) Despite any difficulties in making the necessary calculations, it was likely that the electrodes were also affected by wine vapours as the cells were filled, an effect which could not be quantified. Also the revised value was not expected to differ greatly from the potential minimum observed. The main concern was to find a reproducible value which could be used to compare the redox strengths of different wines, a purpose well served by the potential minimum. The steady value three to four hours into the run was taken to be the redox potential of the unplatinized electrodes.

### 3. Results: factors affecting the measurement procedure

In developing a reproducible measurement procedure a number of different factors were found to affect the redox potential. These initial experiments were all conducted on Mission Vineyards Fumé Blanc 1987.

#### 3.1. Platinization of the electrodes

Figure 3 shows how a potential minimum was quickly established on the various platinized electrodes within an hour as the potential came to coincide with that of the wine, after which time the potential gradually increased, at a rate which slowed after a couple of hours. Here a logarithmic scale for time was used to enhance the initial data. The potential of the unplatinized electrodes, on the other hand, reached a steady value after 3–4 h, sometimes approaching this value from above, sometimes from below, but then changing very little.

The surprising result was that platinized electrodes consistently recorded a potential somewhat lower than unplatinized electrodes. The expectation was that platinized electrodes would be more active and would establish an equilibrium with the solution more rapidly, but would then show the same potential as the unplatinized electrodes. Instead, as the degree of platinization was increased by a factor of 2.7, the measured potential was lower by  $(40 \pm 10)$  mV 1 h into the run, and by  $(25 \pm 5)$  mV 20 h into the run. The potential was thus found to be proportional to the logarithm of the mass degree of platinization, as shown by a log plot of data using nine degrees of platinization, and comparing potentials at three times into the runs (Fig. 4).

When the platinization was increased beyond about  $20 \text{ mg cm}^{-2}$ , deviations from a direct logarithmic relationship were seen. According to Feltham and Spiro the degree of platinization is directly proportional to the real surface area of the electrode [38]. Feltham and Spiro also observed deviations from linearity only beyond  $30 \text{ mg cm}^{-2}$ , consistent with the above findings. It would then seem that the redox potential of a platinized electrode forms a logarithmic relationship with the real surface area of the electrode, that is, with the amount of catalytically active platinum exposed to the wine.

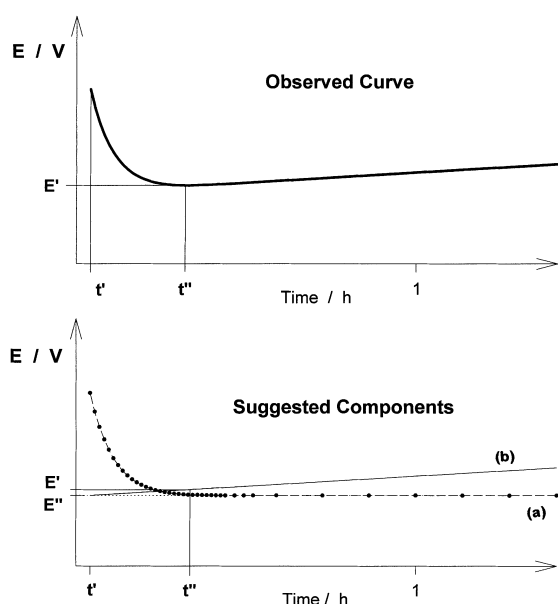

Fig. 2. Observed potential against time curve for a platinized platinum electrode inserted into wine, and suggested components of this curve: (a) theoretical potential stabilization in the absence of poisoning, (b) potential rise due to poisoning,  $t'$ : time the electrode comes in contact with wine,  $t''$ : time at which the potential minimum is observed,  $E'$ : observed potential minimum,  $E''$ : theoretical potential in the absence of poisoning.

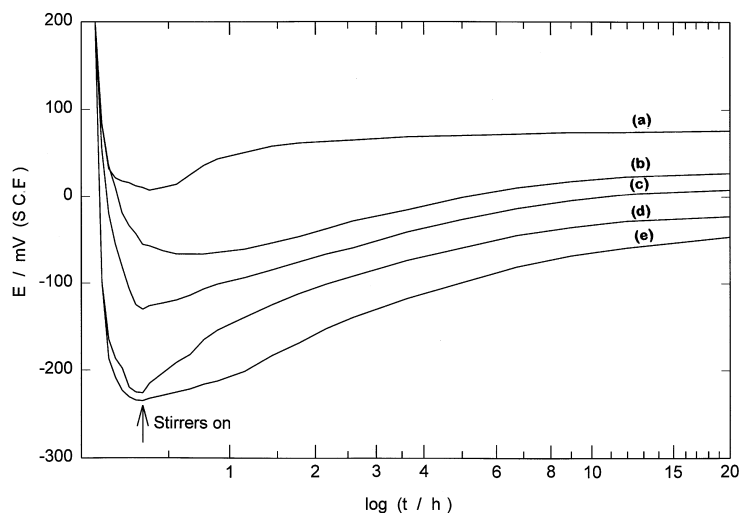

Fig. 3. Electrode potential (SCE) against  $\log(t)$  for a series of platinum wire electrodes: (a) unplatnized; and platinized: (b) 1.3, (c) 3.5, (d) 9.5 and (e)  $26 \text{ mg cm}^{-2}$ .

It is likely that the more heavily platinized electrodes were preferentially activating a system, or systems, of a lower potential. As the platinization increased, these lower potential systems further dominated the measured potential. However, the potential never reached a limiting value; even when the platinization was increased to  $440 \text{ mg cm}^{-2}$  (which required 13 h of platinization), the potential continued to decrease.

It was decided that both unplatnized electrodes and electrodes platinized to a consistent degree should be used in the standard measurement technique. This would provide more information about the redox state of the wine, since different redox systems were being 'sensed' to varying degrees by the two types of platinum electrode.

### 3.2. Geometric surface area of the electrodes

Small disc electrodes of  $0.002 \text{ cm}^2$  area were found to give potentials normally 20 to 30 mV higher than

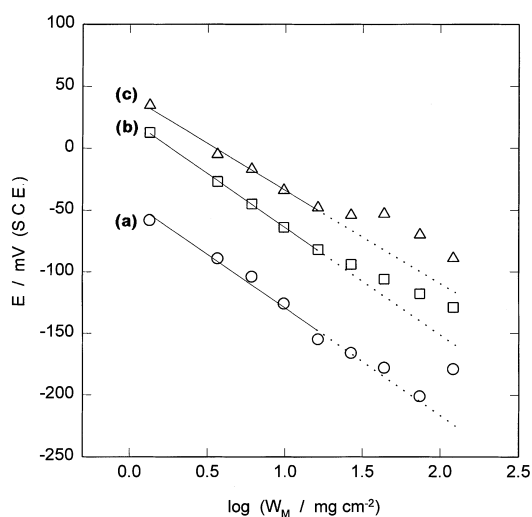

Fig. 4. Electrode potential (SCE) as a function of the degree of platinization at: (a) 1, (b) 5 and (c) 15 h into a run.

larger wire or foil electrodes, an anomaly possibly arising from imperfections such as crevices between the glass and platinum of the electrode. On the other hand,  $3 \text{ cm}^2$  foil electrodes showed the same initial potential values as  $0.08 \text{ cm}^2$  wire electrodes (see Fig. 5), but often reached a potential maximum later in the run, followed by a decline in the redox potential. This later decline was due to an effect on the wine itself, as can be seen by the way a small disc electrode followed the potential decline when in the same cell as a foil electrode; a decline was only observed if foil electrodes were present. By the end of a long run (of 70 h), wine exposed to foil electrodes became darker and acquired a ketonic odour, showing that lengthy exposure to a large quantity of platinum significantly alters the wine composition.

Wire electrodes, however, followed the same development with time as the small disc electrodes, (while noting the consistent potential gap between the two electrode types), showing that the wine was affected to a negligible degree by the presence of platinum wire electrodes. Further, when a fresh wire electrode was introduced into a wine sample in which another wire electrode had already been for 24 h, the same initial potential was recorded as 24 h earlier, showing that the potential of the wine had not changed significantly in that time. Wire electrodes were thus chosen for the standard measurement procedure.

### 3.3. Chemical pretreatment

Deibner and Mourgues have stressed the need for a careful and consistent chemical cleaning of electrodes to achieve rapid stabilization of the potential [12–14, 17, 20, 22–24]. The highly active platinum surface was also thought to be very susceptible to poisoning, particularly following platinization. This was confirmed in a number of instances.

When platinized electrodes were reused without full chemical pretreatment (only rinsing with double

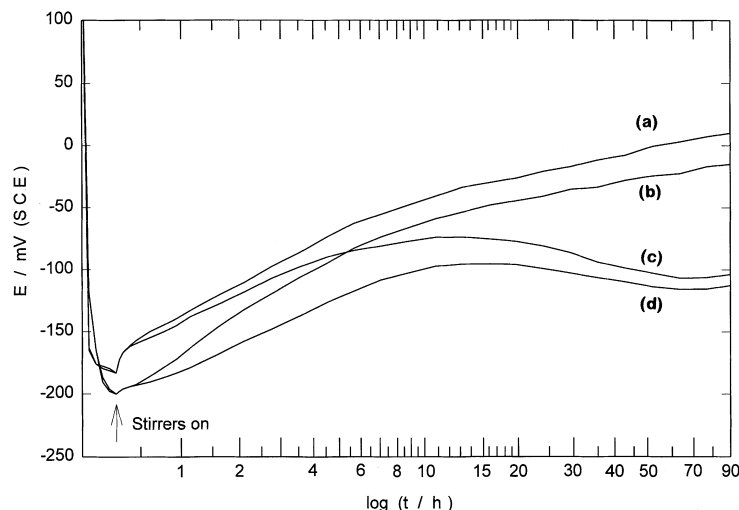

Fig. 5. Electrode potential (SCE) against  $\log(t)$  for a series of platinum electrodes platinized to  $9.5 \text{ mg cm}^{-2}$ : (a)  $0.002 \text{ cm}^2$  disc electrode cell A, (b)  $0.08 \text{ cm}^2$  wire electrode cell A, (c)  $0.002 \text{ cm}^2$  disc electrode cell B, (d)  $3 \text{ cm}^2$  foil electrode cell B.

distilled water), they recorded a potential initially 50 mV higher than fresh electrodes, and still 20 mV higher 24 h into a run. Although washing had removed a number of impurities, some permanent poisoning of the electrode surface had occurred. When platinized electrodes were exposed to the air for two hours before an experiment, the initial potential was about 15 mV higher than otherwise expected, due to adsorption of atmospheric gases. What was most critical for platinized electrodes was any exposure to a wine headspace, which led to rapid poisoning of the electrode. When an electrode was left for 30 min above the wine before immersion, (Fig. 6), the initial minimum was 150 mV higher than that of an electrode immersed from the beginning, and the potentials on the electrodes converged only after some 24 h.

On the other hand, unplatinized electrodes appeared to be less affected by electrode poisoning. Once a steady potential was established it changed

only slowly with time, and when unplatinized electrodes were reused a second time they recorded the same potential as freshly prepared electrodes. In the standard measurement procedure it was decided to consistently use the chemical pretreatment referred to above, and to minimize exposure of the electrodes to wine vapours.

3.4. *Effect of temperature, aeration and light*

The observation of Deibner [12, 16, 17] that a rise in temperature leads to a lowering of the measured potential was confirmed. When the temperature was increased by  $10^\circ\text{C}$ , the potential on both platinized and unplatinized electrodes was found to decrease by 7 to 9 mV. Conversely, decreasing the temperature by  $10^\circ\text{C}$  caused the potential to rise by a similar amount. Hence, the whole measurement system was enclosed in a water jacket and maintained at a constant temperature of  $25.0^\circ\text{C}$ .

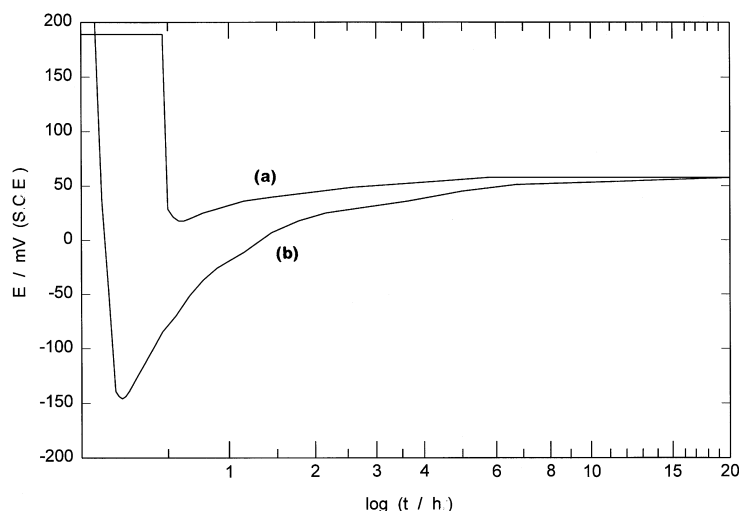

Fig. 6. Electrode potential (SCE) against  $\log(t)$  for platinum wire electrodes platinized to  $9.5 \text{ mg cm}^{-2}$ : (a) electrode inserted 30 min into the run, (b) electrode immersed from the beginning of the run. The wine was stirred from before the electrodes came into contact with the wine (the practice adopted for the standard measurement technique).

It is well known that aeration of a wine causes the potential to rise markedly. If the cells were not first flushed out with oxygen-free nitrogen, sufficient oxygen dissolved into the wine during the filling procedure to raise the potential on both platinized and unplatinized electrodes by some 20 to 30 mV. Any exposure of the wine to oxygen was therefore avoided in the standard measurement technique.

Deibner also observed that exposure to sunlight tends to lower the redox potential of a wine [16]. Fluorescent light was found to induce an immediate change in the potential of a wine, and so minimal exposure to light was considered a priority.

### 3.5. Headspace effects and stirring

It was thought that the loss of volatile species to a headspace could be significant, given that the relative concentrations of oxidized and reduced species would be altered. Indeed, when a second sample was taken from a wine bottle, which had stood with a significant headspace for 24 h, the potential was regularly *down* by 15 mV on the platinized, and *up* by 40 mV on the unplatinized electrodes! This further suggested that different redox systems were being activated by the two types of electrode.

When the cell used to measure the redox potential itself contained a headspace, a significant rise in the potentials of up to 100 mV for both platinized and unplatinized electrodes was observed 4 h into a run. This was not due to a change in the potential of the wine itself, since fresh electrodes immersed later in the run recorded the same initial potential readings as had the original electrodes. Further, when the headspace was flushed out with oxygen-free nitrogen, there was a prolonged decrease in the potentials over 4 h, more marked on the platinized electrodes, suggesting the removal of volatile oxidized species from the solution, after which time the former values were gradually reestablished. It was thus decided to construct cells without a headspace for use in the standard measurement technique, and to take samples only from full wine bottles.

Deibner and Mourgues had noted that the potential is stabilized more quickly when a wine is stirred. They also observed a difference between the potentials of stirred and unstirred samples and preferred to make measurements in the absence of all circulation and agitation [17, 19, 20]. When the wine was stirred using a magnetic stirrer, the initial potential minimum on platinized electrodes was reached more quickly, and the subsequent potential rise was also more rapid. Further, if the stirring was stopped during a run, the potential slowly decreased by 5 to 10 mV over an hour on unplatinized electrodes, and by 3 to 5 mV on platinized electrodes; the former values were reestablished quickly once the stirrers were turned on again.

These results indicated that the redox systems contributing to the mixed potential were diffusion

controlled to varying degrees. If a key system of high potential was the more diffusion controlled (e.g., the reduction of traces of oxygen), it would be expected that the unplatinized electrode would be more greatly affected by stirring, (since its potential value is closer to this system). Further, if the stirring was stopped, the potential on both types of electrode would drop, since the rate constants of the higher potential system would be more greatly reduced, and so the potential would be determined by lower potential systems to a greater extent.

Despite the recommendations of Deibner and Mourgues, it was decided to maintain a steady rate of stirring throughout the measurement period. This also allowed the quasi-equilibrium and the redox potential to be established more rapidly, and importantly, gave much improved reproducibility.

## 4. Results: measured redox potentials

### 4.1. Redox potentials of various New Zealand and foreign wines

The redox potentials and pH of 26 wines were measured using the standard measurement technique and are reported in Table 1. Three of the wines were sweet 'botrytis' wines (up to 25% sugar by weight), while four of the wines were of a lower alcohol content. A linear relationship was observed between the redox potentials and wine pH (Fig. 7), particularly on the platinized electrodes, showing that  $H^+$  ions feature in systems responsible for the redox potential. It has already been suggested [41] that the redox potential in wine will be dependent on the pH in the presence of catalysts such as platinum black owing to equilibria involving  $H^+$  ions. A linear regression analysis for 21 of the wines (excluding the 4 lower alcohol wines and a 1971 wine which had clearly deteriorated), produced a good linear fit for the platinized electrodes while there was greater scatter with the unplatinized electrodes. The fact that the gradients were different for platinized ( $-83$  mV per pH unit) and unplatinized electrodes ( $-120$  mV per pH unit), along with the 150 to 200 mV difference in the values themselves, indicated further that different redox systems were contributing to the mixed potential for these two types of electrode. These results indicated that the pH should be measured alongside the redox potential, with deviations from the normal potential-pH curve being more significant than the value of the potential alone.

Further, when  $5\text{ cm}^3$  of concentrated sulfuric acid solution was introduced into a wine sample, the potential changed by 50 to 60 mV per pH unit for both platinized and unplatinized electrodes, (over and above the rise of up to 70 mV for the addition of the same quantity of double distilled water, perhaps due to the introduction of dissolved oxygen). These values are consistent with the 60 mV potential change per pH unit reported by Deibner and Mourgues for the addition of 0.1 M HCl or 0.1 M NaOH [17].

Table 1. Redox potential (SCE) on  $9.50 \text{ mg cm}^{-2}$  platinized and unplatinized electrodes, pH, rH and alcohol content (as quoted on the bottle) of 26 wines

Measurements made in 1988

Wine	pH	Alc./%	Platinized		Unplatinized	
			E/mV	rH	E/mV	rH
Mission "Tokay D'Alsace" 1987	3.38	13	-225	7.3	-17	14.3
Mission "Tokay D'Alsace" 1985	3.23	11.7	-222	7.1	16	15.1
Mission "Tokay D'Alsace" 1984	3.34	-	-220	7.4	-66	12.5
Mission "Tokay D'Alsace" 1983	3.41	11.5	-228	7.3	-95	11.7
Mission "Tokay D'Alsace" 1982	3.28	11.5	-208	7.7	-63	12.5
Mission "Tokay D'Alsace" 1981	3.39	12	-215	7.7	-23	14.1
St. Helena "Pinot Noir" 1986	4.07	13	-281	6.8	-119	12.2
St. Helena "Pinot Noir" 1985	4.21	13.5	-290	6.8	-139	11.9
St. Helena "Pinot Noir" 1984	3.82	12.5	-263	6.9	-159	10.4
St. Helena "Pinot Noir" 1983	3.95	12	-275	6.8	-128	11.7
Ngatarawa "Chardonnay" 1987	3.45	12.5	-232	7.2	-41	13.6
McWilliams "Riesling" 1971	3.44	-	-258	6.3	-56	13.1
McWilliams "Riesling" 1972	3.23	-	-199	7.9	-61	12.5
Mission "Reserve Claret" 1981	3.68	11.5	-252	7.0	-111	11.7
Vidals "Pinot Noir" 1986	3.72	11.9	-253	7.1	-92	12.4
Sartori "Amorone" 1980	3.37	14	-206	7.9	-29	13.8
Cotes Rhone "Villages" 1985	3.62	14	-258	6.7	-38	14.0
Sacred Hill "Fume Blanc" 1987	3.55	12.8	-224	7.7	-26	14.3
Villa "Gewurztraminer" 1987	3.95	10.2*	-261	7.3	-97	12.7
Villa "Gewurztraminer" 1986	3.58	12.3	-228	7.6	-58	13.3
Alsace "Gewurztraminer" 1982	3.97	-	-253	7.6	-92	12.9
Reunite "D'Oro"	3.42	7.5*	-209	7.9	102	18.3
Deinhard "Riesling Kabinett"	3.14	8.1*	-166	8.8	-4	14.2
Te Whare "Botrytis" 1987	3.60	10.2*	-231	7.6	1	15.3
Heggies "Botrytis" 1986	3.44	13	-233	7.2	-43	13.5
Heggies "Botrytis" 1983	3.37	13	-229	7.2	-55	13.0

\*lower alcohol wines

The pH dependence of the redox potential has been accounted for by past researchers [31, 33, 34, 41] through the use of a measure known as the 'rH', a function of the electrode potential on the hydrogen scale (Eh):

$$rH = \frac{Eh + 0.06 \text{ pH}}{0.03} \quad (1)$$

anticipated for a potential-pH slope of 60 mV per pH unit. The rH values for the redox potentials given in Table 1 range from 6.3 to 8.8 on the platinized electrodes (7.3 average), and from 10.4 to 18.3 on the unplatinized electrodes (13.3 average). The rH values for the unplatinized electrodes are lower than those given by Dikanovic-Lucan and Palic for 61 wines with a range of 16.42 to 22.03 [34], but closer to an earlier study they quote of 77 Yugoslav wines by Milisavljevic with a range from 13.50 to 18.40 [42], while Russu *et al.* obtained rH values from 15 to 20 for table wines [31]. These differences may relate to the experimental procedures employed, and illustrate the difficulties in comparing results from different research groups. For example, Dikanovic-Lucan and Palic circulated a nitrogen atmosphere through the wine during the measurement, presumably released through a headspace. As noted above, a cell with a headspace can lead to a rise in the electrode potential by up to 100 mV (3.3 rH values).

Deibner and Mourgues preferred to record the potential and pH separately owing to the nonuniform influence of the addition of acid or alkali on the potential [17]. The present results suggest that a measure similar to the rH might still be used but based upon a potential-pH slope more characteristic of the particular electrode, (e.g. 83 mV per pH unit for

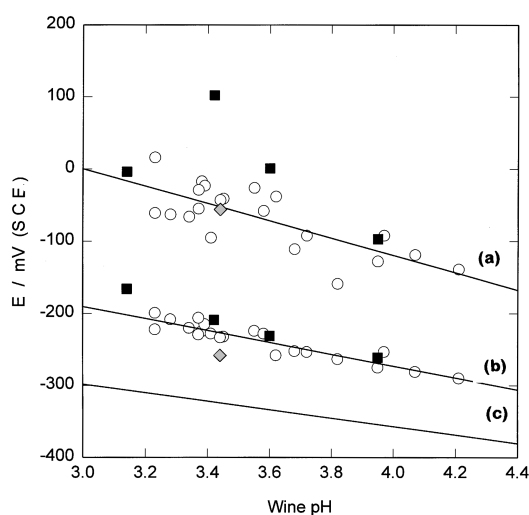

Fig. 7. Redox potential of 26 wines as a function of pH for platinum wire electrodes: (a) unplatinized, (gradient  $-120 \text{ mV per pH unit}$ , correlation coeff. 0.58), (b) platinized to  $9.5 \text{ mg cm}^{-2}$ , (gradient  $-83 \text{ mV per pH unit}$ , correlation coeff. 0.87). Filled squares indicate low alcohol wines, while the diamonds represent a 1971 Riesling Sylvaner which had clearly deteriorated. Line (c) represents the theoretical values for the ethanol/ethanal system, using  $E^\circ = -32 \text{ mV (SCE)}$  and an ethanol concentration 1000 times that of ethanal, (i.e.,  $a_{\text{CH}_3\text{CH}_2\text{OH}} : a_{\text{CH}_3\text{CHO}} = 1000$ ).

9.5 mg cm<sup>-2</sup> platinized electrodes). Alternatively, the above results may reflect a trend noted elsewhere [29], that a high pH value contributes to a lowering of the redox potential of the wine with time.

The redox potentials on the platinized electrodes for the four lower alcohol wines lay above the potential–pH curve. These observations suggest that ethanol may feature in a system contributing to the redox potential, although more experiments are required to substantiate this claim. The direction of the potential shift is consistent with the ethanol/ethanal system as a low potential system. Included in Fig. 7 is the theoretical line for ethanol/ethanal system:



assuming a concentration ratio  $a_{\text{CH}_3\text{CH}_2\text{OH}}:a_{\text{CH}_3\text{CHO}}$  of 1000, and based on the standard potential of –32 mV (SCE), as measured in 1983 at Victoria University by J.N.M. Lee.

The data for sweet wines showed no distinguishing characteristics, suggesting that systems involving sugar did not contribute significantly to the redox potential. Further no difference was observed between red and white wines, or between different wine varieties, except that the potentials for the spicy Gewurztraminer wines were 10 to 20 mV higher than otherwise expected.

However, for a 17 year old Riesling Sylvaner, which from tasting had clearly deteriorated, the measured redox potential on the platinized electrode was markedly lower than for the other wines. On the other hand, no deterioration was evident for a 16 year old Riesling Sylvaner and the redox potential was likewise of an average value.

For 21 of the wines measured, the reproducibility of the electrodes was tested by comparing the potentials in two different measurement cells. Good reproducibility was obtained, particularly with the platinized electrodes. An average difference of only 2.2 mV on platinized electrodes is better than the best reproducibility of  $\pm 5$  mV claimed previously using unplatinized electrodes [8, 12, 32]. In only two of the 21 runs was the difference in the potentials of the two platinized electrodes greater than 4 mV. An average difference of 5.5 mV was obtained for the unplatinized electrodes, and the difference in nine of the 21 runs was greater than 4 mV.

## 5. Discussion: value of the measured potential

The redox potential of wine has been measured using platinum electrodes in numerous studies over the past 60 years [5–34]. At the 10th International Congress of Vines and Wines in 1962, the expression for the redox state of wine Eh was defined along with methods for its determination, while the need for simultaneous pH measurements was acknowledged [17]. The effect of dissolved oxygen has also long been known as affecting the redox potential, but to a different extent with different wines [29, 43]. Further, a lowering of the potential has been observed following treatment with

H<sub>2</sub>, SO<sub>2</sub> or ascorbic acid [11, 18, 44]. However, the constituents of wine which further determine the redox potential have been hard to identify, with all the redox couples in the solution thought to play a role [32]. Nevertheless, the redox potential has been seen to provide a valid indicator of the oxidizing or reducing force of the solution as it determines the course of maturation of the wine. Russu *et al.*, for example, have specified an rH value of 19 as the point beyond which a wine is in a highly oxidizing state, while below rH 17 the wine has reducing properties [31].

However, owing to the complexity of the medium involved, the full significance of the values obtained is still unresolved. The formation of deposits of reduced or oxidized species on the electrode surface, or general poisoning of the electrode, has often been seen as interfering with the measurement, especially for lengthy exposure of platinum electrodes to wine [24, 29, 32]. Moreover, little note has been made in the literature on the redox potential of wine to research conducted on the behaviour of platinum electrodes exposed to pure solutions of organic molecules such as ethanol.

The appearance of a potential minimum on a platinized platinum electrode at open circuit when exposed to a solution of organic molecules is well known [45]. The factors affecting the establishment of this potential minimum and its subsequent rise has been the subject of some debate, with the influence of absorbed substances and their subsequent changes being seen as critical [45, 46]. The initial potential minimum has been said to reflect the relative speeds of the hydrogenation, dehydrogenation and self-hydrogenation of organics which might be oxidized or reduced at a platinum electrode, a combination of reactions which could differ for different alcohols [46–48], with some specific features noted for methanol [49, 50]. The potential is then controlled primarily by the equilibrium between adsorbed hydrogen derived from the organic molecules and protons (in acidic solution) or water (in alkaline solution), since the rate constant for this reaction is faster than other possible systems. As a result the electrode ends up with a certain covering of adsorbed hydrogen and a range of other adsorbates, with the extent of chemisorption dependent upon the particular irreversible reactions of the organic molecules. The measured redox potential of wine will also be influenced by such processes, which are expected to be even more complex in nature.

The subsequent change in potential has been ascribed to the poisoning action of organic species. The assumed role of CO in this process [45] has more recently received spectroscopic confirmation for the case of ethanol at a platinum electrode [51]. The present experiments also showed that platinized platinum is very susceptible to poisoning. The gradual increase of potential on the platinized electrodes gave the appearance of active sites being blocked, with the electrode behaving as if it had been platinized to a lesser degree, consistent with a decrease of real surface area exposed to the wine.



The concept of a mixed potential due to a variety of chemical reactions lies at the heart of many previous explanations for the behaviour of platinum in organic solutions. The critical reactions in wine may include a combination of irreversible breakdown of organic molecules leaving adsorbates on the surface, adsorbed H in equilibrium with hydronium ions, traces of oxygen and other electroactive species arriving at the electrode, along with the chemicals involved in general wine maturation donating or receiving electrons from the redox electrode. The peculiarities of the electrocatalytic surface will determine the relative exchange current densities for each process, further affecting the measured redox potential, the differences in the values obtained for platinized and unplatinized electrodes in wine reflect this point.

Against this picture of complexity, it may be possible to suggest how a pair of redox processes may explain a number of the experimental trends noted above and illustrate how the redox potential is generated as a mixed potential. The mixed potential might be largely due to an oxidation reaction, such as the oxidation of ethanol to ethanal, a system of lower potential, coupled to reduction reactions such as oxygen (or proton) reduction, a system of higher potential. With oxygen reduction limited by the diffusion of oxygen from the solution to the electrode surface (and largely independent of the electrode roughness), this reaction is enhanced by good stirring conditions, leading to an increase in the mixed potential with stirring, as observed experimentally. The oxidation of ethanol, on the other hand, will be under activation control, and will be more responsive to the particular catalytic properties of the redox electrode and to an increase in the exposed real surface area (i.e., the roughness factor). Hence as the degree of platinization and roughness factor is increased, the exchange currents for the ethanol/ethanal system increase and the mixed potential is lowered in the direction of the ethanol/ethanal system, again in line with experimental observations. The appearance of a ketonic odour for wine exposed to 3 cm<sup>2</sup> foil electrodes for 70 h is consistent with oxidation processes of this sort. Conversely, the loss of active sites on the platinized electrode through poisoning will lead to lower exchange currents for the ethanol/ethanal system, explaining the increase in the measured potential with time.

Finally, the implications of the present research extend beyond the measurement of the redox potential of wine to include redox potentials recorded in a variety of complex organic (or inorganic) media, from biological fluids to soil waters. In each case the specific electrocatalytic activity of the electrode material must be taken into account. The possibility that systems central to the redox activity of the medium itself might be outweighed by other systems preferentially activated on the metal catalyst should never be overlooked. In this regard the use of a variety of

redox probes can only increase the amount of information gained from such measurements.

## 6. Conclusions

Differences in the redox potential of wine were found between platinized and unplatinized platinum electrodes, including the values of the measured potentials, the amount of potential change when the stirrers were turned off, the direction of the potential change for successive samples of wine, and the values of the potential against pH gradients. The redox potential was measured with greater precision using platinized electrodes, while poisoning affected platinized electrodes more than unplatinized electrodes. More information can be gained about the redox state of a wine by using both types of electrode, although the sensitivity of the measurement makes controlled laboratory conditions essential.

## Acknowledgement

We are grateful to Mission Vineyards, Hawkes Bay, New Zealand, for supplying wine samples for this research and to Gillian Dudgeon for preliminary experiments.

## References

- [1] R. David, *Radiat. Environ. Biophys.* **25** (1986) 219.
- [2] M. J. Barcelona, T. R. Holm, M. R. Schock and G. K. George, *Water Resour. Res.* **25** (1989) 991.
- [3] C. G. Cogger, P. E. Kennedy and D. Carlson, *Soil Sci.* **154** (1992) 50.
- [4] D. D. Macdonald, A. C. Scott and P. Wentreck, *J. Electrochem. Soc.* **128** (1981) 250.
- [5] J. Geloso, *Chem. Indust.* **27** (1932) 430.
- [6] M. A. Joslyn and R. Dunn, *J. Am. Chem. Soc.* **60** (1938) 1137.
- [7] J. Ribereau-Gayon, *Ann. Fals. Fraudes* **32** (1939) 385.
- [8] M. A. Joslyn, *Ind. Eng. Chem.* **41** (1949) 587.
- [9] E. N. Costa, *Am. J. Enol. Viticult.* **10** (1959) 56.
- [10] M. Cortes, *Ind. Aliment. Agr.* **79** (1962) 829.
- [11] V. L. Singleton and D. E. Draper, *Am. J. Enol. Viticult.* **14** (1963) 23.
- [12] L. Deibner, *Ann. Inst. Natl. Recherche Agron., Ser E., Ann. Technol. Agr.* **5** (1956) 31.
- [13] *Idem, Inds. Agr. Aliment.* **74** (1957) 273.
- [14] *Idem, Ann. Inst. Natl. Recherche Agron., Ser E* **6** (1957) 313.
- [15] *Idem, ibid.* **6** (1957) 347.
- [16] *Idem, ibid.* **6** (1957) 363.
- [17] L. Deibner and J. Mourgues, *Ann. Technol. Agr.* **13** (1964) 31.
- [18] *Idem, Ind. Aliment. Agr.* **81** (1964) 1075.
- [19] *Idem, C. R. Acad. Sci., Paris Ser. D* **263** (1966) 1333.
- [20] L. Deibner, *Bull. Off. Int. Vigne Vin* **39** (1966) 312.
- [21] L. Deibner and J. Mourgues, *ibid.* **39** (1966) 929.
- [22] *Idem, ibid.* **40** (1967) 1041.
- [23] *Idem, Chim. Anal. (Paris)* **49** (1967) 258.
- [24] *Idem, Ind. Aliment. Agr.* **84** (1967) 751.
- [25] J. Mourgues, P. Bernard, C. Flanzky and C. Jouret, *Ann. Technol. Agr.* **16** (1967) 333.
- [26] J. Mourgues and L. Deibner, *Ind. Aliment. Agr.* **84** (1967) 1483.
- [27] L. Deibner and J. Mourgues, *Mitt. Rebe. Wein, Obstbau Fruchteverwert* **19** (1969) 289.
- [28] J. Ribereau-Gayon, 'Sciences et Techniques du Vin', Tome III, Dunod, Paris, (1973) p. 646.
- [29] V. V. Nilov, *Vinogradarstvo I Vinodelie. Resp. Mezhd. Temat. Nauch. Sb.* **18** (1975) 26.

- [30] E. G. Zhizhilashvili, *Izv. Akad. Nauk Gruz. SSR, Ser. Khim.* **6** (1980) 358.
- [31] E. I. Russu and A. S. Maksimova, *Sadovod. Vinograd. Vinodel. Mold.* **7-9** (1992) 25.
- [32] N. Vivas, F. Zamora and Y. Glories, *J. Int. Sci. Vigne Vin.* **26** (1992) 271.
- [33] A. Palic, V. Vojnovic and N. Vahcic, *Monatsschr. Brauwiss.* **44** (1991) 73.
- [34] Z. Dikanovic-Lucan and A. Palic, *Z. Lebensm. Unters. Forsch.* **195** (1992) 133.
- [35] B. B. Damaskin, O. A. Petrii and V. V. Batrakov, 'Adsorption of Organic Compounds on Electrodes', Plenum Press, New York (1971), p. 471.
- [36] O. A. Khazova, Yu. B. Vasil'ev and V. S. Bagotskii, *Elektrokhimiya* **2** (1966) 267.
- [37] B. I. Podlovchenko and R. P. Petukhova, *ibid.* **6** (1970) 198.
- [38] A. M. Feltham and M. Spiro, *Chem. Rev.* **71** (1971) 177.
- [39] *Idem*, *J. Electroanal. Chem.* **35** (1972) 181.
- [40] J. J. Kirkland and J. H. Yoe, *Anal. Chim. Acta* **9** (1953) 441.
- [41] J. Ribereau-Gayon, 'Sciences et Techniques du Vin', Tome I, Dunod, Paris (1973), p. 515.
- [42] D. Milisavljevic, *Letopis poljoprivrednog fakulteta Novi Sad* **5** (1961) 114.
- [43] J. Ribereau-Gayon *et al.*, 'Sciences et Techniques du Vin', Tome III, p. 640.
- [44] *Idem*, *Ibid.* p. 644.
- [45] B. Piersma and E. Gileadi, in 'Modern Aspects of Electrochemistry', vol. 4, (edited by J. O'M. Bockris), Plenum Press, New York (1966), p. 102ff.
- [46] B. I. Podlovchenko, O. A. Petrii, A. N. Frumkin, *Dokl. Akad. Nauk SSSR* **153** (1963) 379.
- [47] B. I. Podlovchenko, *Elektrokhimiya* **1** (1965) 101.
- [48] B. I. Podlovchenko, O. A. Petry, A. N. Frumkin and H. Lal, *J. Electroanal. Chem.* **11** (1966) 12.
- [49] B. I. Podlovchenko, O. A. Petrii, and E. P. Gorgonova, *Elektrokhimiya* **1** (1965) 182.
- [50] O. A. Petry, B. I. Podlovchenko, A. N. Frumkin and H. Lal, *J. Electroanal. Chem.* **10** (1965) 253.
- [51] H. Hitmi, E. M. Belgsir, J. M. Leger, C. Lamy and R. O. Lenza, *Electrochim. Acta* **39** (1994) 407.